

BL Pi-Tron CM3+

Doc. Rev. 1.1

kontron

This page has been intentionally left blank

▶ BL PI-TRON CM3+ USER GUIDE

Disclaimer

Kontron Electronics would like to point out that the information contained in this user guide may be subject to alteration, particularly as a result of the constant upgrading of Kontron Electronics products. This document does not entail any guarantee on the part of Kontron Electronics with respect to technical processes described in the user guide or any product characteristics set out in the user guide. Kontron Electronics assumes no responsibility or liability for the use of the described product(s), conveys no license or title under any patent, copyright or mask work rights to these products and makes no representations or warranties that these products are free from patent, copyright or mask work right infringement unless otherwise specified. Applications that are described in this user guide are for illustration purposes only. Kontron Electronics makes no representation or warranty that such application will be suitable for the specified use without further testing or modification. Kontron Electronics expressly informs the user that this user guide only contains a general description of processes and instructions which may not be applicable in every individual case. In cases of doubt, please contact Kontron Electronics.

This user guide is protected by copyright. All rights are reserved by Kontron Electronics. No part of this document may be reproduced, transmitted, transcribed, stored in a retrieval system, or translated into any language or computer language, in any form or by any means (electronic, mechanical, photocopying, recording, or otherwise), without the express written permission of Kontron Electronics. Kontron Electronics points out that the information contained in this user guide is constantly being updated in line with the technical alterations and improvements made by Kontron Electronics to the products and thus this user guide only reflects the technical status of the products by Kontron Electronics at the time of publishing.

Brand and product names are trademarks or registered trademarks of their respective owners.

©2022 by Kontron Electronics GmbH

YOUR CONTACT

Kontron Electronics GmbH

Max-Planck-Str. 6
72636 Frickenhausen
Germany
www.kontron-electronics.com

GLOBAL HEADQUARTERS

Kontron Europe GmbH

Gutenbergstr. 2
85737 Ismaning
Germany
www.kontron.com

Intended Use

THIS DEVICE AND ASSOCIATED SOFTWARE ARE NOT DESIGNED, MANUFACTURED OR INTENDED FOR USE OR RESALE FOR THE OPERATION OF NUCLEAR FACILITIES, THE NAVIGATION, CONTROL OR COMMUNICATION SYSTEMS FOR AIRCRAFT OR OTHER TRANSPORTATION, AIR TRAFFIC CONTROL, LIFE SUPPORT OR LIFE SUSTAINING APPLICATIONS, WEAPONS SYSTEMS, OR ANY OTHER APPLICATION IN A HAZARDOUS ENVIRONMENT, OR REQUIRING FAIL-SAFE PERFORMANCE, OR IN WHICH THE FAILURE OF PRODUCTS COULD LEAD DIRECTLY TO DEATH, PERSONAL INJURY, OR SEVERE PHYSICAL OR ENVIRONMENTAL DAMAGE (COLLECTIVELY, "HIGH RISK APPLICATIONS").

You understand and agree that your use of Kontron Electronics devices as a component in High-Risk Applications is entirely at your risk. To minimize the risks associated with your products and applications, you should provide adequate design and operating safeguards. You are solely responsible for compliance with all legal, regulatory, safety, and security related requirements concerning your products. You are responsible to ensure that your systems (and any Kontron Electronics hardware or software components incorporated in your systems) meet all applicable requirements. Unless otherwise stated in the product documentation, the Kontron Electronics device is not provided with error-tolerance capabilities and cannot therefore be deemed as being engineered, manufactured or setup to be compliant for implementation or for resale as device in High-Risk Applications. All application and safety related information in this document (including application descriptions, suggested safety measures, suggested Kontron Electronics products, and other materials) is provided for reference only.

Revision History

Revision	Brief Description of Changes	Date of Issue	Author/Editor
Rev. 0.1	Initial version	2020-10-06	We
Rev. 1.0	Final release	2022-02-28	We
Rev. 1.1	New logos, minor corrections	2023-08-21	We

Terms and Conditions

Kontron Electronics warrants products in accordance with defined regional warranty periods. For more information about warranty compliance and conformity, and the warranty period in your region, visit <https://www.kontron-electronics.de/downloads/>.

For contact information, refer to the corporate offices contact information on the last page of this user guide or visit our website [CONTACT US](#).

Customer Support

Find Kontron Electronics contacts by visiting: www.kontron-electronics.com

Customer Comments

If you have any difficulties using this user guide, discover an error, or just want to provide some feedback, contact support@kontron-electronics.de. Detail any errors you find. We will correct the errors or problems as soon as possible and provide the revised user guide.

Symbols

The following symbols may be used in this user guide

⚠ DANGER

DANGER indicates a hazardous situation which, if not avoided, will result in death or serious injury.

⚠ WARNING

WARNING indicates a hazardous situation which, if not avoided, could result in death or serious injury.

NOTICE

NOTICE indicates a property damage message.

⚠ CAUTION

CAUTION indicates a hazardous situation which, if not avoided, may result in minor or moderate injury.



Electric Shock!

This symbol and title warn of hazards due to electrical shocks (> 60 V) when touching products or parts of products. Failure to observe the precautions indicated and/or prescribed by the law may endanger your life/health and/or result in damage to your material.



ESD Sensitive Device!

This symbol and title inform that the electronic boards and their components are sensitive to static electricity. Care must always therefore be taken during all handling operations and inspections of this product in order to ensure product integrity.



HOT Surface!

Do NOT touch! Allow to cool before servicing.



Laser!

This symbol informs of the risk of exposure to laser beam and light emitting devices (LEDs) from an electrical device. Eye protection per manufacturer notice shall review before servicing.



This symbol indicates general information about the product and the user guide.

This symbol also indicates detail information about the specific product configuration.



This symbol precedes helpful hints and tips for daily use.

For Your Safety

Your new Kontron Electronics product was developed and tested carefully to provide all features necessary to ensure its compliance with electrical safety requirements. It was also designed for a long fault-free life. However, the life expectancy of your product can be drastically reduced by improper treatment during unpacking and installation. Therefore, in the interest of your own safety and of the correct operation of your new Kontron Electronics product, you are requested to conform with the following guidelines.

High Voltage Safety Instructions

As a precaution and in case of danger, the power connector must be easily accessible. The power connector is the product's main disconnect device.

⚠ CAUTION**Warning**

All operations on this product must be carried out by sufficiently skilled personnel only.

⚠ CAUTION**Electric Shock!**

Before installing a non-hot-swappable Kontron Electronics product into a system always ensure that the power is switched off. This also applies to the installation of piggybacks. Serious electrical shock hazards can exist during all installation, repair, and maintenance operations on this product. Therefore, always unplug the power cable and any other cables which provide external voltages before performing any work on this product.

Earth ground connection to vehicle's chassis or a central grounding point shall remain connected. The earth ground cable shall be the last cable to be disconnected or the first cable to be connected when performing installation or removal procedures on this product.

General Safety Instructions for IT Equipment

⚠ WARNING



Please read this chapter carefully and take careful note of the instructions that have been compiled for your safety and to ensure to apply in accordance with intended regulations. If the following general safety instructions are not observed, it could lead to injuries to the operator and/or damage of the product; in cases of non-observance of the instructions Kontron Electronics is exempt from accident liability, this also applies during the warranty period.

The product has been built and tested according to the basic safety requirements for low voltage (LVD) applications and has left the manufacturer in safety-related, flawless condition. To maintain this condition and to ensure safe operation, the operator must not only observe the correct operating conditions for the product but also the following general safety instructions:

- ▶ The product must be used as specified in the product documentation, in which the instructions for safety for the product and for the operator are described. These contain guidelines for setting up, installation and assembly, maintenance, transport and storage.
- ▶ The on-site electrical installation must meet the requirements of the country's specific local regulations.
- ▶ If a power cable comes with the product, only this cable should be used. Do not use an extension cable to connect the product.
- ▶ To guarantee that enough air circulation is available to cool the product, ensure that if the product has ventilation openings the openings are not covered or blocked. If an air filter is provided, this should be cleaned regularly. Additionally, make sure the system is well ventilated by observing if heat-dissipating elements are covered/obstructed by objects as this can cause a build-up of heat and stop heat from being dispersed into the ambient environment.
- ▶ Do not place the system close to heat sources or damp places.
- ▶ Only products or parts which fulfil the requirements of SELV circuits (Safety Extra Low Voltage) as stipulated by IEC 60950-1 may be connected to the available interfaces.
- ▶ If the product is modified by insertion or removal of expansion devices (depending on the configuration of the system), this may only be carried out by qualified persons.
- ▶ If extensions are made to the product, the following must be observed:
 - ▶ All effective legal regulations and all technical data for the expansion devices are adhered to.
 - ▶ The power consumption of any expansion devices does not exceed the specified limitations.
 - ▶ The current consumption of the system does not exceed the value stated on the product label.
- ▶ Only original accessories that have been approved by Kontron Electronics can be used.
- ▶ Please note: safe operation is no longer possible when any of the following applies:
 - ▶ Damage is visible.
 - ▶ The device no longer functions.
 In these cases, the device must be switched off and it must be ensured that the device can no longer be operated.

Additional Safety Instructions for DC Power Supply Circuits

- ▶ To guarantee safe operation of products with DC power supply voltages larger than 60 volts DC or a power consumption larger than 240 VA, please observe that:
 - ▶ The product is set up, installed and operated in a room or enclosure marked with "RESTRICTED ACCESS", if there are no safety messages on product as safety signs and labels on the product itself.
 - ▶ No cables or parts without insulation in electrical circuits with dangerous voltage or power should be touched directly or indirectly.
 - ▶ A reliable protective earthing connection is provided.
 - ▶ A suitable, easily accessible disconnecting product is used in the application (e.g. overcurrent protective product), if the product itself is not disconnectable.
 - ▶ A disconnect product, if provided in or as part of the equipment, shall disconnect both poles simultaneously.
 - ▶ Interconnecting power circuits of different products causes no electrical hazards.
- ▶ A sufficient dimensioning of the power cable wires must be selected - according to the maximum electrical specifications on the product label - as stipulated by EN60950-1 or VDE0100 or EN60204 or UL508 regulations.
- ▶ The product does not generally fulfil the requirements for "centralized DC power systems "(UL 60950-1, Annex NAB; D2) and therefore may not be connected to such products!

Special Handling and Unpacking Instruction

NOTICE



ESD Sensitive Device!

Electronic boards and their components are sensitive to static electricity. Therefore, care must be taken during all handling operations and inspections of this product, in order to ensure product integrity at all times.

Do not handle this product out of its protective enclosure while it is not used for operational purposes unless it is otherwise protected.

Whenever possible, unpack or pack this product only at EOS/ESD safe workstations. Where a safe workstation is not guaranteed, it is important for the user to be electrically discharged before touching the product with his/her hands or tools. This is most easily done by touching a metal part of your system housing.

It is particularly important to observe standard anti-static precautions when changing piggybacks, ROM devices, SD cards, jumper settings etc. If the product contains batteries for RTC or memory backup, ensure that the product is not placed on conductive surfaces, including anti-static plastics or sponges. They can cause short circuits and damage the batteries or conductive circuits on the product.

Lithium Battery Precautions

If your product is equipped with a lithium battery, take the following precautions when replacing the battery.

⚠ CAUTION

Danger of explosion if the battery is replaced incorrectly.

- ▶ Replace only with same or equivalent battery type recommended by the manufacturer.
 - ▶ Dispose of used batteries according to the manufacturer's instructions.
-

General Instructions on Usage

In order to maintain Kontron Electronics' product warranty, this product must not be altered or modified in any way. Changes or modifications to the product, that are not explicitly approved by Kontron Electronics and described in this user guide or received from Kontron Electronics Support as a special handling instruction, will void your warranty.

This product should only be installed in or connected to systems that fulfil all necessary technical and specific environmental requirements. This also applies to the operational temperature range of the specific board version that must not be exceeded. If batteries are present, their temperature restrictions must be considered.

In performing all necessary installation and application operations, only follow the instructions supplied by the present user guide.

Keep all the original packaging material for future storage or warranty shipments. If it is necessary to store or ship the product then re-pack it in the same manner as it was delivered.

Special care is necessary when handling or unpacking the product. See Special Handling and Unpacking Instruction.

Quality and Environmental Management

Kontron Electronics aims to deliver reliable high-end products designed and built for quality, and aims to complying with environmental laws, regulations, and other environmentally oriented requirements. For more information regarding Kontron Electronics' quality and environmental responsibilities, visit

<https://www.kontron-electronics.com/company/about-us/germany/>

Disposal and Recycling

Kontron Electronics' products are manufactured to satisfy environmental protection requirements where possible. Many of the components used are capable of being recycled. Final disposal of this product after its service life must be accomplished in accordance with applicable country, state, or local laws or regulations.

WEEE Compliance

The Waste Electrical and Electronic Equipment (WEEE) Directive aims to:

- ▶ Reduce waste arising from electrical and electronic equipment (EEE).
- ▶ Make producers of EEE responsible for the environmental impact of their products, especially when the product become waste.
- ▶ Encourage separate collection and subsequent treatment, reuse, recovery, recycling and sound environmental disposal of EEE.
- ▶ Improve the environmental performance of all those involved during the lifecycle of EEE.



Environmental protection is a high priority with Kontron Electronics.
Kontron Electronics follows the WEEE directive.
You are encouraged to return our products for proper disposal.

Table of Contents

Symbols.....	6
For Your Safety.....	7
High Voltage Safety Instructions	7
Special Handling and Unpacking Instruction	9
Lithium Battery Precautions.....	10
General Instructions on Usage.....	10
Quality and Environmental Management	10
Disposal and Recycling.....	10
WEEE Compliance.....	10
Table of Contents	11
List of Tables.....	13
List of Figures	13
1/ Introduction.....	14
1.1. Product Overview.....	14
1.2. Ordering Information	15
1.3. Accessories	15
2/ Specification.....	16
2.1. Technical Specification.....	16
2.2. Mechanical Specification	16
2.3. Power Specification	18
2.3.1. Power Consumption	18
2.3.2. Functional Earthing System	19
2.3.3. Environmental Specification	19
2.4. Block Diagram	20
3/ Connector Description	21
3.1. Overview	21
3.1.1. Power Connector	22
3.1.2. Micro-HDMI Interface.....	22
3.1.3. Ethernet (LAN2, LAN1) Interface.....	22
3.1.4. USB 2.0 Interface	22
3.1.5. RS232 Interface	22
3.1.6. CAN Interface	22
3.1.7. RS485 Interface.....	22
3.1.8. DIO Interface.....	23
3.1.9. USB OTG Interface.....	23
3.1.10. MicroSD Card Slot.....	23
3.1.11. +5 V Display Connector	23
3.1.12. CSI (Camera Serial Interface)	23
3.1.13. DSI (Display Serial Interface)	23
3.1.14. 40-pin RPI-GPIO-Header	24
3.1.15. Debug Interface	24
3.1.16. Fan Connector	24
3.1.17. Functional Earth Connection	24
3.2. Connector Pin Assignments.....	25
3.2.1. Input Power Connector (X3).....	25
3.2.2. Micro-HDMI Connector (X500).....	25
3.2.3. Ethernet RJ45 Connectors (X600, X700).....	26
3.2.4. USB Connector (X601)	26
3.2.5. RS232 Connector (X15)	26
3.2.6. RS485/CAN Connector (X18).....	27

3.2.7. DIO Connector (X19).....	27
3.2.8. USB OTG Connector (X402)	27
3.2.9. MicroSD Card Slot (X400)	28
3.2.10. +5 V Display Connector (X1201)	28
3.2.11. CSI Connector (Camera Serial Interface, X1001)	28
3.2.12. DSI Connector (Display Serial Interface, X1000)	29
3.2.13. 40-pin RPI-GPIO-Header (X800).....	29
3.2.14. USB Debug Connector (X401).....	30
3.2.15. Fan Connector (X1200)	30
4/ Accessing Components	31
4.1. Accessing External Components	31
4.1.1. MicroSD Card Slot	31
5/ Thermal Considerations.....	32
5.1. Passive Cooling.....	32
6/ Installation Instructions.....	33
6.1. Requirements IEC60950-1.....	33
6.2. Power Connector	33
6.2.1. Wiring the DC Mating Power Connector	34
7/ Starting Up.....	35
7.1. Connecting to Power Supply	35
7.2. Operating System (OS) and Drivers.....	35
8/ Standards, Certifications and Directives	36
9/ Shipment and Unpacking	37
9.1. Packaging.....	37
9.2. Unpacking	37
9.3. Type Label and Product Identification.....	37
10/ Technical Support	38
10.1. First Steps - Startup-Information Baseboard.....	38
10.2. Extended Support	38
10.3. Disclaimer & License Information.....	38
11/ Storage, Transportation and Maintenance.....	39
11.1. Storage.....	39
11.2. Transportation	39
11.3. Maintenance.....	39
11.3.1. Replacing the Lithium Battery.....	39
12/ Warranty	40
12.1. Limitation/Exemption from Warranty Obligation.....	40
13/ Disposal	41
Appendix.....	42
List of Acronyms	42
About Kontron Electronics	43

List of Tables

Table 1: Scope of Delivery	15
Table 2: Accessories	15
Table 3: Technical Specification	16
Table 4: Software Specification.....	16
Table 5: Mechanical Specification.....	16
Table 6: Power Specification	18
Table 7: Power Consumption.....	19
Table 8: Environmental Specification.....	19
Table 9: Overview of all Connectors	21
Table 10: Standards, Certifications and Directives Compliance.....	36
Table 11: List of Acronyms	42

List of Figures

Figure 1: BL Pi-Tron CM3+	14
Figure 2: Dimensions.....	17
Figure 3: Power Tree.....	18
Figure 4: Block Diagram	20
Figure 5: Top Side View.....	21
Figure 6: UART-USB Adapter	30
Figure 7: Phoenix Power Mating Connector	33
Figure 8: BL Pi-Tron CM3+ Type Label (Example).....	37

1/ Introduction

This user guide describes the Board-Line BL Pi-Tron CM3+. New users are recommended to study the installation instructions within this user guide before switching on the power.

Kontron Electronics' BL Pi-Tron CM3+ is developed specifically for easy entry into the world of professional industrial controls, with a wide range of interfaces and for use when space is limited. The fanless design ensures a significantly prolonged lifespan and high system availability.

1.1. Product Overview

Before working with the BL Pi-Tron CM3+, Kontron Electronics recommends that users take a few minutes to learn about the various parts of the BL Pi-Tron CM3+.

The BL Pi-Tron CM3+ is a flexible single board computer fanless device designed for use in demanding applications. Based on the Pi-Tron (4x Arm® Cortex®-A53, 1x Arm® Cortex®-M4) Quad processor the BL Pi-Tron CM3+ features long-term availability and supports a varied number of onboard interfaces to enable connectivity to nearly all applications. A microSD card slot supports memory expansion for flexible data storage.

All variants are also available as a separate product named Automation-Line AL Pi-Tron CM3+ in a robust steel chassis, designed for operation in a DIN rail environment using a vertical orientation.

Please contact us for detailed information or visit: <http://www.kontron-electronics.de>

General features are:

- ▶ Broadcom® BCM2837B0 4x Arm® Cortex®-A53 @1,2 GHz
- ▶ 1 GB RAM with LPDDR2 soldered memory
- ▶ 8 GB or 32 GB memory storage via soldered eMMC
- ▶ External microSD card slot or internal eMMC flash drive
- ▶ External Interfaces: 1x Micro-HDMI, 2x 10/100 Mbit/s Ethernet, 2x USB 2.0 Host, 1x USB OTG (only for programming eMMC), 1x RS232, 1x RS485, 1x CAN, 4x DIO (24 V/up to 800 mA), 1x CSI, 1x DSI, 1x 40-pin RPI-GPIO-Header, 1x Debug Interface, 1x Fan Connector, 1x +5 V Display Connector
- ▶ Fanless passive cooling (heatsink required)

The BL Pi-Tron CM3+ is intended for 24/7 continuous operation and longtime industrial applications. All components are selected to ensure a long lifetime.

Figure 1: BL Pi-Tron CM3+



The BL Pi-Tron CM3+ is designed for operation in a customer-specific enclosure or device. Please do not operate the BL Pi-Tron CM3+ without sufficient cooling system. The maximum temperature range refers only to the limits of the individual components.

1.2. Ordering Information

Check that your delivery is complete, and contains the items listed below. If you discover damaged or missing items, contact your dealer.

Table 1: Scope of Delivery

Art.-No.	Delivered Item	Description
40099 196	BL Pi-Tron CM3+ lite 1GB/microSD Slot	Corresponding to the ordered product configuration
40099 197	BL Pi-Tron CM3+ 1GB/8GB	Corresponding to the ordered product configuration
40099 198	BL Pi-Tron CM3+ 1GB/32GB	Corresponding to the ordered product configuration
	Other systems on request	

1.3. Accessories

Table 2: Accessories

Art.-No.	Delivered Item	Description
10600 338	MicroSD Card	MicroSD Card 16 GB
30099 001	Power Supply	External power supply 230 V AC to 24 V DC / 18 W incl. 2-pin power connector (Phoenix Contact origin no. 1826680)
30099 006	Connector Set RS232/RS485/CAN/DIO mating connector	Connector set contains: 1x RS232: 8-pin; 1x RS485/CAN: 8-pin; 1x DIO: 8-pin (Phoenix Contact origin no. 1844594)
40099 101	USB-UART Adapter	Translates the UART signals provided on the Mini-B USB connector to USB for connecting the BL Pi-Tron CM3+ to a computer

2/ Specification

2.1. Technical Specification

The BL Pi-Tron CM3+ implements the following mainboard technical specification.

Table 3: Technical Specification

Processor	4x Arm® Cortex®-A53 @1,2 GHz
System Memory	LPDDR2-RAM 1 GB
Storage	8 GB or 32 GB eMMC Or microSD card
Interfaces	2x USB 2.0, USB A 1x USB OTG, Micro-USB 1x 1 Gbit/s, 1x 10/100 Mbit/s Ethernet 1x Micro-HDMI 1x RS232, 1x RS485 1x CAN 4x DIO (24 V DC/up to 800 mA) 1x Debug, USB Mini-B 1x Fan 1x +5 V (Display) 1x CSI 1x DSI 1x 40-pin RPI-GPIO-Header
Expansion Sockets	1x external microSD card slot or internal eMMC flash drive
Power	24 V DC ±20 % Input

Table 4: Software Specification

Operating Systems (OS)	Raspberry Pi OS (Raspbian), Yocto, Windows IOT, Ubuntu Desktop/Server/Core, LibreElec, RetroPie and others BSP (demo) documentation and support: https://docs.kontron-electronics.de
------------------------	---

2.2. Mechanical Specification

Table 5: Mechanical Specification

Dimensions	BL Pi-Tron CM3+
Width	105.5 mm (4.15")
Depth	67 mm (2.64")
Height	24 mm (0.94") without Header / 28 mm (1.10") with Header
Weight	Approx. ~0.07 kg (~0.15 lbs.)
Mounting	Screw mounting (M2.5)

For more detailed mechanical information, refer to the outline dimensions drawing within this chapter. Each dimension drawing shows the main external mechanical features such as the position and size of mounting holes (all Measurements in millimetres).

Figure 2: Dimensions

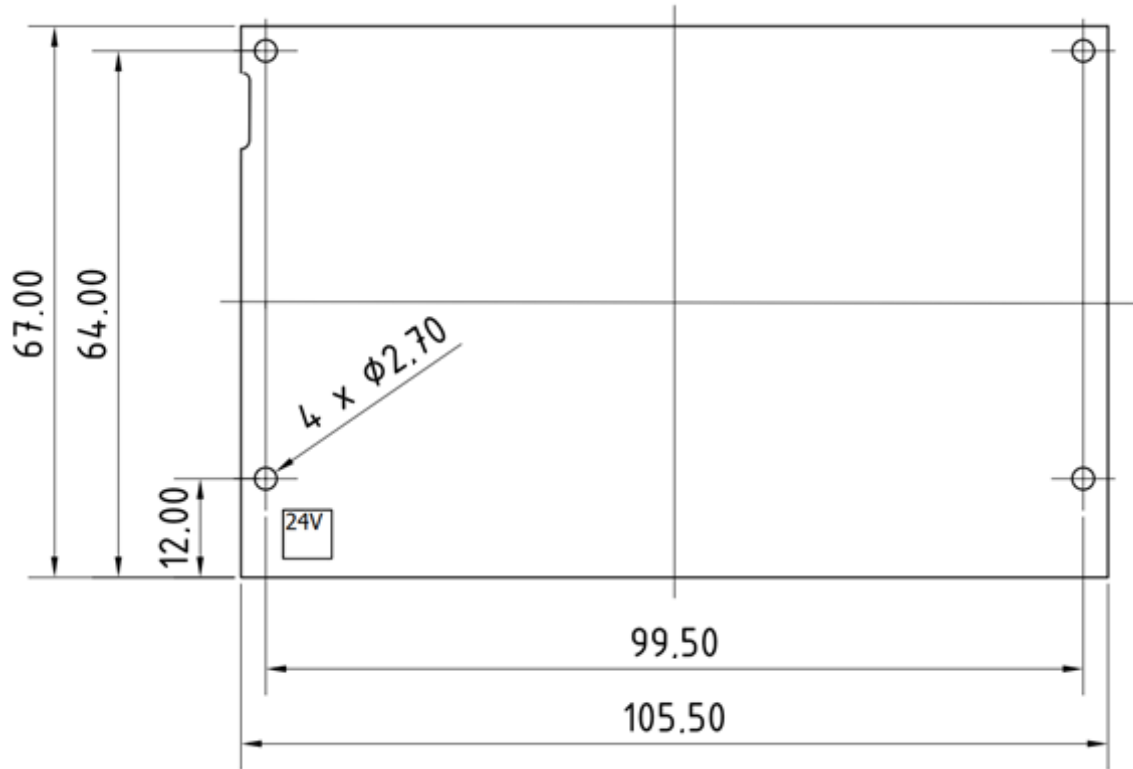

2.3. Power Specification

The BL Pi-Tron CM3+ is powered by a 2-pin input power connector on the front and has no internal power supply. The standard input voltage of 24 V DC is converted internally to supply all other required voltages.

NOTICE Hot Plugging the power supply is not supported. Hot plugging might damage the board.

Table 6: Power Specification

Nominal Input Voltage	24 V DC
Input Voltage Range	24 V DC ±20 %
Input Power	Max. 3 A (connector current)
Output Current 3.3 V	Max. 100 mA
Output Current 5 V	Max. 2 A
Output Current DOUT	Max. 2 A
Input Power Mating Connector	2-pin Phoenix Contact 180° FMC 1,5/2-ST-3,5 (Phoenix 1826680)

NOTICE The maximum output current of all outputs together is divided between the 5 V and 3 V paths. The maximum output currents for 5 V and 3 V given in the table above each refer to the use of this voltage only and are reduced accordingly when using both voltages.

2.3.1. Power Consumption

The power consumption of the BL Pi-Tron CM3+ depends on the implemented mainboard capacity and external interfaces, for more information see Table 7: Power Consumption.

Figure 3: Power Tree

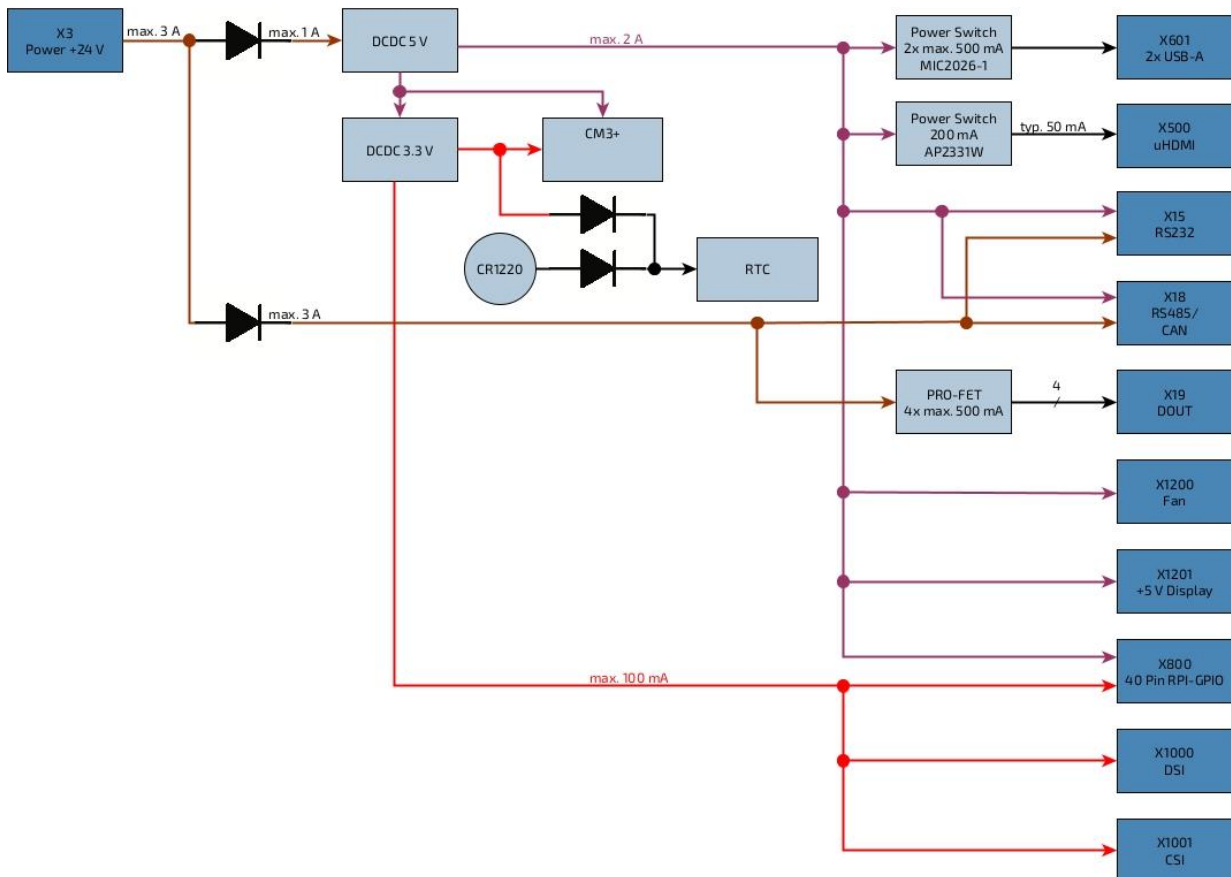

Table 7: Power Consumption

Power Figures SBC	BL Pi-Tron CM3+
BL Pi-Tron CM3+ Deep Sleep Mode	not supported
BL Pi-Tron CM3+ idle performance	2.7 W
BL Pi-Tron CM3+ run	2.7...9 W
1x HDMI (typ.)	50 mA * 5 V = 250 mW
LAN 1	1 W
LAN 2	900 mW
2x USB 2.0	2x 500 mA * 5 V = 5 W
DOUT	4x 500 mA * 24 V = 48 W

2.3.2. Functional Earthing System

A functional earth connection to the board will be possible via the four mounting holes. These contact surfaces are directly attached to the electronic ground and the GND pin of the power connector.

2.3.3. Environmental Specification

Table 8: Environmental Specification

Temperature (Operating)	0°C...55°C ambient
Relative Humidity (Operating)	93% @ 40 °C, non-condensing
Pollution Degree	Class II



The BL Pi-Tron CM3+ is designed for operation in a customer-specific enclosure or device. Please do not operate the BL Pi-Tron CM3+ without sufficient cooling system. The maximum temperature range refers only to the limits of the individual components.

2.4. Block Diagram

Figure 4: Block Diagram

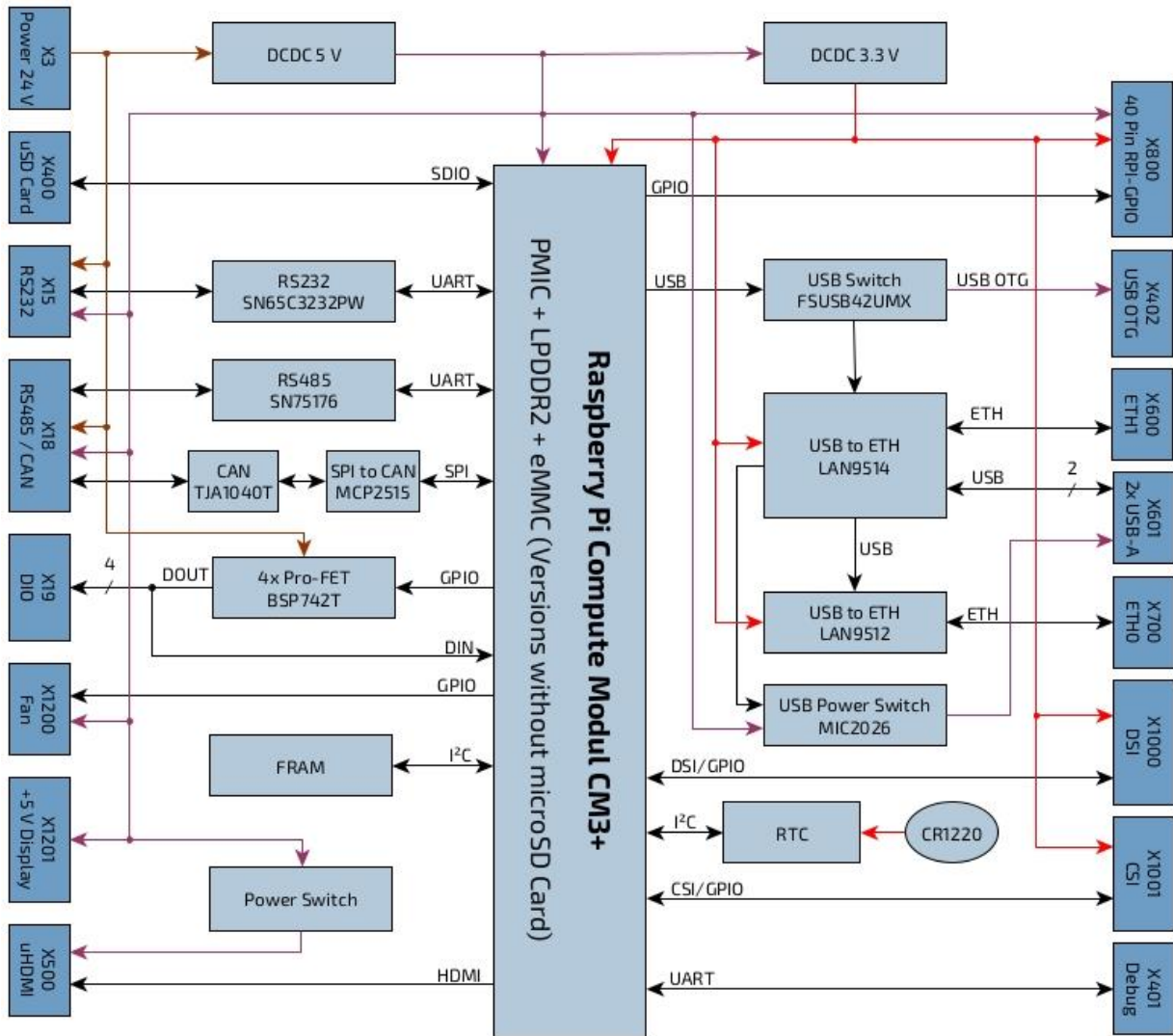

3/ Connector Description

3.1. Overview

The front includes most of the I/O connectors.

Figure 5: Top Side View

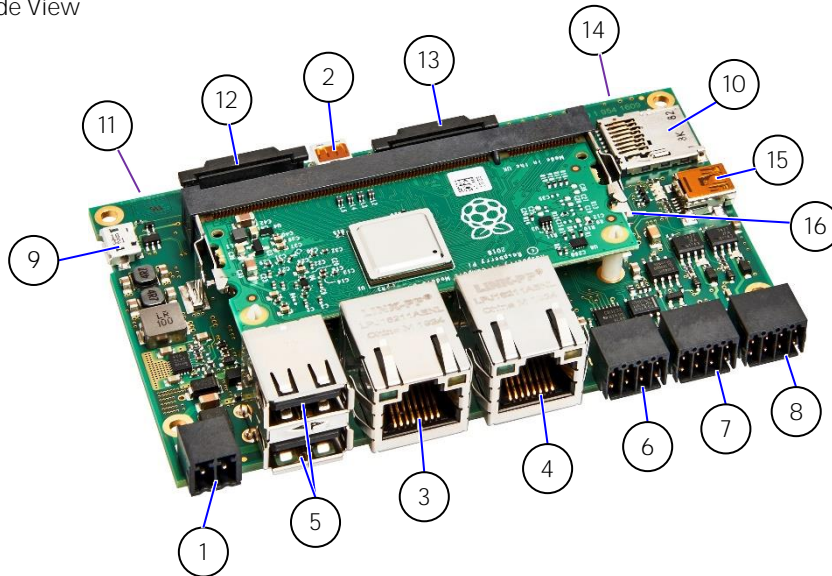

Table 9: Overview of all Connectors

Item	Label	Function	See Chapter
1	X3	DC Power Connector (2-pin Phoenix Contact)	3.2.1
2	X500	Micro-HDMI Connector	3.2.2
3	X600	10/100 Mbit/s LAN2 RJ-45 Connector	3.2.3
4	X700	10/100 Mbit/s LAN1 RJ-45 Connector	3.2.3
5	X601	USB 2.0 Port 0 / 1 Connector (upper / lower)	3.2.4
6	X15	RS232 Connector	3.2.5
7	X18	RS485 / CAN Connector	3.2.6
8	X19	DIO Connector	3.2.7
9	X402	USB OTG Connector (only for programming eMMC)	3.2.8
10	X400	MicroSD Card Slot (only <i>L/te</i> version)	3.2.9
11	X1201	+5 V Display Connector (bottom side)	3.2.10
12	X1001	CSI1 Connector (Camera Serial Interface)	3.2.11
13	X1000	DSI1 Connector (Display Serial Interface)	3.2.12
14	X800	40-pin RPI-GPIO-Header (bottom side)	3.2.13
15	X401	Debug Connector	3.2.14
16	X1200	Fan Connector	3.2.15

3.1.1. Power Connector

There is one 2-pin power connector on the top side supporting an input DC voltage range of 24 V DC $\pm 20\%$, see Figure 5 (pos. 1). The mating connector required to connect the power connector to a DC main power source is supplied with the BL Pi-Tron CM3+. For information on how to connect the supplied mating connector to the input power connector, refer to Chapter 6.2.1: Wiring the DC Mating Power Connector.

For the pin assignment of the Input power connector, refer to Chapter 3.2.1: Input Power Connector.

3.1.2. Micro-HDMI Interface

There is one Micro-HDMI interface (1920 x 1080 pixel), for video/audio solutions, see Figure 5 (pos. 2). The HDMI interface is not designed for connecting cables longer than 3 m. Depending on the monitor and the installation situation, a suitable HDMI cable with folding ferrite must be selected.

For the pin assignment of the Micro-HDMI connector, refer to Chapter 3.2.2: Micro-HDMI Connector (X500).

3.1.3. Ethernet (LAN2, LAN1) Interface

There are two LAN ports, see Figure 5 (pos. 3 and 4). In the software these are referred to as ETH0 and ETH1. The assignment between LAN2/LAN1 and ETH0/ETH1 depends on the software.

In order to achieve the specified performance of the Ethernet port, shielded category 5 twisted pair cables must be used with 10/100 Mbit/s LAN networks.

For the pin assignment of the RJ45 Ethernet connectors, refer to Chapter 3.2.3: Ethernet RJ45 Connectors (X600, X700).

3.1.4. USB 2.0 Interface

There are two USB 2.0 ports allowing for the connection of USB 2.0 compatible devices, see Figure 5 (pos. 5). The USB ports are designed for connecting short cables only.

For the pin assignment of the USB 2.0 connector, refer to Chapter 3.2.4: USB Connector (X601).

3.1.5. RS232 Interface

There is a RS232 interface supporting RS232 RX/TX without RTS/CTS, see Figure 5 (pos. 6). The RS232 interface is not designed for connecting cables longer than 3 m.

For the pin assignment of the RS232 connector, refer to Chapter 3.2.5: RS232 Connector (X15).

3.1.6. CAN Interface

The CAN interface in Figure 5 (pos. 7) also contains the wiring for RS485. The CAN address can only be changed by software. The CAN interface is not designed for connecting cables longer than 30 m.

For the pin assignment of the RS485 / CAN connector, refer to Chapter 3.2.6: RS485/CAN Connector (X18).

3.1.7. RS485 Interface

The RS485 interface in Figure 5 (pos. 7) also contains the wiring for CAN. The RS485 interface is not designed for connecting cables longer than 30 m.

For the pin assignment of the RS485 / CAN connector, refer to Chapter 3.2.6: RS485/CAN Connector (X18).

3.1.8. DIO Interface

There is a four port DIO interface available on the front of the BL Pi-Tron CM3+, see Figure 5 (pos. 8).

The DIO pins consist of a 24 V high side switch, capable of driving 800 mA. The voltage level is according to the supply voltage. When the output is disabled, the pin can be used as 24 V input.

The DIO interface is not designed for connecting cables longer than 30 m.

For the pin assignment of the DIO connector, refer to Chapter 3.2.7: DIO Connector (X19).

3.1.9. USB OTG Interface

There is a Micro-USB OTG interface for programming the eMMC or microSD card, see Figure 5 (pos. 9).

The USB OTG interface is for service and should only be used by qualified personnel.

For the pin assignment of the USB OTG connector, refer to Chapter 3.2.8: USB OTG Connector (X402).

3.1.10. microSD Card Slot

The Pi-Tron can be obtained with two different types of Compute Module. One without *eMMC* memory, the "*Lite*" version, and the "*eMMC*" version. The notable difference between the *Lite* and the *eMMC* Compute Module is that the "*Lite*" version can only boot and use the microSD card and the "*eMMC*" version can only boot and use the *eMMC* memory, but not the microSD card. If there is a microSD card slot, see Figure 5 (pos.10).

For the pin assignment of the microSD card slot, refer to Chapter 3.2.9: microSD Card Slot (X400).



Pay attention to the manufacturer's lifespan specification. Due to the limited lifespan of microSD Cards/SSD drives Kontron Electronics recommends checking the condition regularly.

3.1.11. +5 V Display Connector

There is a +5 V connector intended to supply a display or other devices, see Figure 5 (pos. 11). In the standard version, the +5 V connector is not fitted.

For the pin assignment of the +5 V Display connector, refer to Chapter 3.2.10 +5 V Display Connector.

3.1.12. CSI (Camera Serial Interface)

There is a CSI interface to connect a Raspberry Pi compatible camera, see Figure 5 (pos. 12). For the pin assignment of the CSI connector, refer to Chapter 3.2.11 CSI Connector (Camera Serial Interface, X1001).

3.1.13. DSI (Display Serial Interface)

There is a DSI interface to connect a Raspberry Pi compatible display, see Figure 5 (pos. 13). For the pin assignment of the DSI connector, refer to Chapter 3.2.12 DSI Connector (Display Serial Interface, X1000).

3.1.14. 40-pin RPI-GPIO-Header

The intended 40-pin header can be used just like the header on the Raspberry Pi 3+, e.g. as GPIO or as an RGB interface, see Figure 5 (pos. 14). The header also contains some of the other interfaces, e.g. the debug interface. If this is used in the header, it cannot be used in the USB connector at the same time. In the standard version, the header is not fitted.

For the pin assignment of the 40-pin RPI-GPIO-Header, refer to Chapter 3.2.13 40-pin RPI-GPIO-Header (X800).

3.1.15. Debug Interface

There is a debug interface using UART protocol with a Mini-B USB connector, see Figure 5 (pos. 15). The Debug interface is for service and should only be used by qualified personnel.

An additional adapter is needed to translate the 3.3 V UART signals (provided on the Mini-B USB connector) to USB. The debug interface is for service purpose and should only be used by qualified personnel.

For the pin assignment of the debug connector, refer to Chapter 3.2.14 USB Debug Connector (X401).

3.1.16. Fan Connector

There is a fan connector to control a 5 V fan via GPIO 12 (PWM), see Figure 5 (pos. 16). For the pin assignment of the fan connector, refer to Chapter 3.2.15 Fan Connector (X1200).

3.1.17. Functional Earth Connection

The GND pin of the power connector is connected to functional earth of the electronics and to the four mounting holes on the edges of the circuit board.

3.2. Connector Pin Assignments

3.2.1. Input Power Connector (X3)

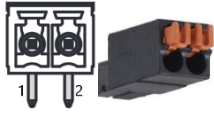
2-Pin Power Mating Connector	Pin	Signal Name
	1	VCC
	2	GND

Phoenix Contact Connector 180° FMC 1,5/2-ST-3,5 (Phoenix 1826680)

3.2.2. Micro-HDMI Connector (X500)

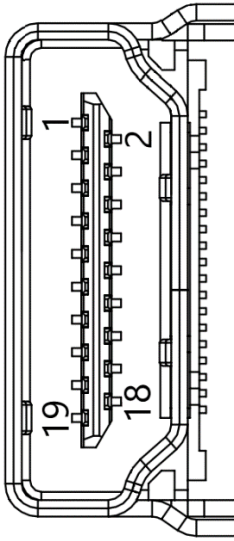
Micro-HDMI Typ D	Pin	Signal Name
	1	Hot Plug Detect
	2	Reserved
	3	TMDS Data2+
	4	TMDS Data2 GND
	5	TMDS Data2-
	6	TMDS Data1 +
	7	TMDS Data1 GND
	8	TMDS Data1-
	9	TMDS Data0+
	10	TMDS Data0 GND
	11	TMDS Data0-
	12	TMDS Clock+
	13	TMDS Clock GND
	14	TMDS Clock-
	15	CEC
	16	DDC_GND
	17	DDC_SCL
	18	DDC_SDA
	19	+5 V Power

3.2.3. Ethernet RJ45 Connectors (X600, X700)

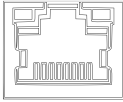
RJ45 (female)	Pin	Signal Name	Pin	Signal Name
	1	TX+	5	n.c.
	2	TX-	6	RX-
	3	RX+	7	n.c.
	4	n.c.	8	n.c.

Left LED: Activity / Link		Right LED: Activity 10/100	
Off	10 Mbit/s	Off	No LAN connectivity
Green	100 Mbit/s	Yellow	Link
		Blinking	Activity

3.2.4. USB Connector (X601)

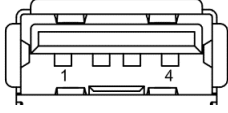
2x USB A 2.0	Pin	Signal Name
	1	+USB_VCC
	2	D-
	3	D+
	4	GND

3.2.5. RS232 Connector (X15)

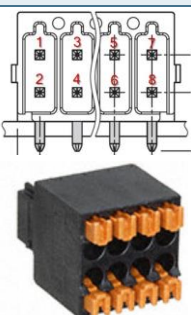
RS232 Interface	Pin	RS232
	1	VIN
	2	GND
	3	TxD
	4	RxD
	5	NC
	6	NC
	7	+5 V DC
	8	GND

Phoenix Contact Connector 180° DFMC 0,5/4-ST-2,54 (Phoenix 1844594)

3.2.6. RS485/CAN Connector (X18)

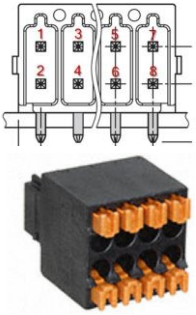
RS485/CAN Interface	Pin	Signal Name
	1	VIN
	2	GND
	3	RS485 A
	4	CAN H
	5	RS485 B
	6	CAN L
	7	+5 V DC
	8	GND

Phoenix Contact Connector 180° DFMC 0,5/4-ST-2,54 (Phoenix 1844594)

3.2.7. DIO Connector (X19)

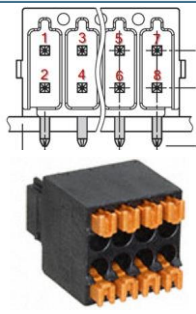
DIO Connector	Pin	Signal Name	Pin	Signal Name
	1	DOUT1 / DIN1 DOUT I _{max} = 800 mA	2	GND
	3	DOUT2 / DIN2 DOUT I _{max} = 800 mA	4	GND
	5	DOUT3 / DIN3 DOUT I _{max} = 800 mA	6	GND
	7	DOUT4 / DIN4 DOUT I _{max} = 800 mA	8	GND

Phoenix Contact Connector 180° DFMC 0,5/4-ST-2,54 (Phoenix 1844594)

3.2.8. USB OTG Connector (X402)

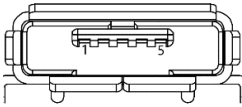
Micro-USB Connector	Pin	Signal Name
	1	+USB_VCC
	2	D-
	3	D+
	4	NC
	5	GND / Shield

3.2.9. MicroSD Card Slot (X400)

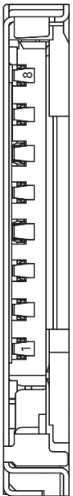
MicroSD Card Slot	Pin	Signal Name
	1	DAT2
	2	CD/DAT3
	3	CMD
	4	VDD
	5	CLK
	6	VSS
	7	DAT0
	8	DAT1

3.2.10. +5 V Display Connector (X1201)

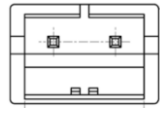
2-Pin Mating Connector	Pin	Signal Name
	1	+ 5V
	2	GND

3.2.11. CSI Connector (Camera Serial Interface, X1001)

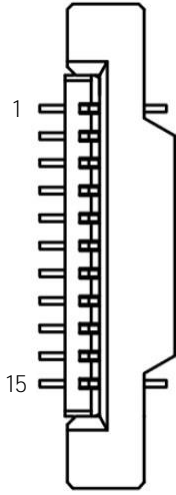
1-1734248-5	Pin	Signal Name
	1	GND
	2	CAM1_DN0
	3	CAM1_DP0
	4	GND
	5	CAM1_DN1
	6	CAM1_DP1
	7	GND
	8	CAM1_CN
	9	CAM1_CP
	10	GND
	11	CAM1_IO0
	12	CAM1_IO1
	13	GPIO1
	14	GPIO0
	15	+3.3 V

3.2.12. DSI Connector (Display Serial Interface, X1000)

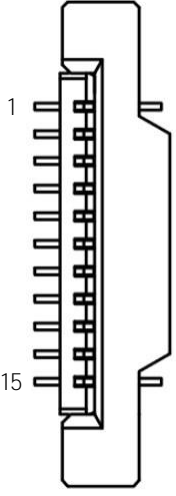
1-1734248-5	Pin	Signal Name
	1	GND
	2	DSI1_DN1
	3	DSI1_DP1
	4	GND
	5	DSI1_CN
	6	DSI1_CP
	7	GND
	8	DSI1_DN0
	9	DSI1_DPO
	10	GND
	11	GPIO1
	12	GPIO0
	13	GND
	14	+3.3 V
	15	+3.3 V

3.2.13. 40-pin RPI-GPIO-Header (X800)

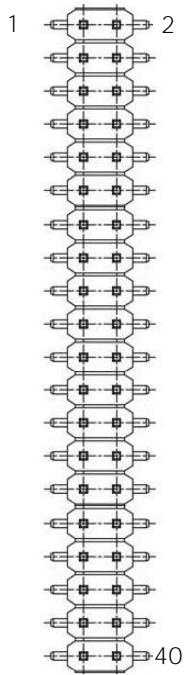
40pol.	Pin	Signal Name	Pin	Signal Name
	1	+3.3 V	21	GPIO9
	2	+5 V	22	GPIO25
	3	GPIO2	23	GPIO11
	4	+5 V	24	GPIO8
	5	GPIO3	25	GND
	6	GND	26	GPIO7
	7	GPIO4	27	GPIO0
	8	GPIO14	28	GPIO1
	9	GND	29	GPIO5
	10	GPIO15	30	GND
	11	GPIO17	31	GPIO6
	12	GPIO18	32	GPIO12
	13	GPIO27	33	GPIO13
	14	GND	34	GND
	15	GPIO22	35	GPIO19
	16	GPIO23	36	GPIO16
	17	+3.3 V	37	GPIO26
	18	GPIO24	38	GPIO20
	19	GPIO10	39	GND
	20	GND	40	GPIO21

3.2.14. USB Debug Connector (X401)

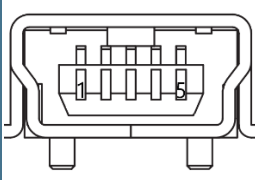
Mini-B USB Connector	Pin	Signal Name
	1	VCC
	2	RXD (D-)
	3	TXD (D+)
	4	N.C.
	5	GND

An additional adapter is needed to translate the UART signals provided on the Mini-B USB connector to USB. This adapter must be connected between an USB port on your computer and the debug interface on the BL Pi-Tron CM3+ using a standard USB cable.

Figure 6: UART-USB Adapter



This adapter is only supplied as standard with our development kits but can also be ordered separately.

For more detailed information please have a look at the online documentation <https://docs.kontron-electronics.de>.

This documentation includes all information you need to put your device into operation including a quick start guide as well as further information on how to get access to the Yocto based GitLab software repository and how to make your own software images.

3.2.15. Fan Connector (X1200)

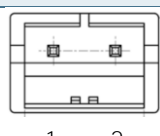
2-Pin Mating Connector	Pin	Signal Name
	1	+5 V
	2	Open drain to GND, controlled via GPIO12 with PWM

4/ Accessing Components

This chapter contains important information that users must read before accessing components. Follow these procedures properly when accessing or installing components to extend the system.

WARNING

The installation/removal of system components may only be performed by a qualified person. Observe the "General Safety Instructions for IT-Equipment" and the "installation instructions" contained within this user guide.



ESD Sensitive

Follow the safety instructions for components that are sensitive to electrostatic discharge (ESD). Failure to observe this warning notice may result in damage to the product or/and internal components.



Because of the limited predetermined lifespan of expansion devices, Kontron Electronics recommends checking the condition of installed expansion devices regularly and to pay attention to the manufacturer specifications for lifespan.

4.1. Accessing External Components

4.1.1. MicroSD Card Slot

The BL Pi-Tron CM3+ supports a removable microSD card.

To remove/install a removable microSD card, perform the following steps:

1. Press the microSD card on the right-hand side of the BL Pi-Tron CM3+, to remove a microSD card out of the slot.
2. The microSD card automatically slides out a bit for removal.
3. Slide in the microSD card, if needed. Take care of the correct position.

5/ Thermal Considerations

⚠ WARNING**Hot Surface**

Danger of burns. Board can get very hot. To avoid burns and personal injury:

- Do not touch the board when the product is in operation
 - Allow the product to cool before handling
 - Wear protective gloves
 - Always turn the product off when not in use
-

5.1. Passive Cooling

The BL Pi-Tron CM3+ is a fanless and passively cooled system. When mounting the BL Pi-Tron CM3+ in a housing take care not to obstruct the airflow over the components, as this stops sufficient heat dispersing into the ambient environment and causes a build-up of heat.



The BL Pi-Tron CM3+ is designed for operation in a customer-specific enclosure or device. Please do not operate the BL Pi-Tron CM3+ without sufficient cooling system. The maximum temperature range refers only to the limits of the individual components.

6/ Installation Instructions

6.1. Requirements IEC60950-1

Take care when designing chassis interface connectors in order to fulfil the IEC60950-1 standard. Users of BL Pi-Tron CM3+ must evaluate the end product to ensure compliance the requirements of the IEC60950-1 safety standard are met:

- ▶ The motherboard must be installed in a suitable mechanical, electrical and fire enclosure.
- ▶ The system in its enclosure must be evaluated for temperature and air flow considerations.
- ▶ The motherboard must be powered by a CSA or UL approved power supply that limits the maximum input current to 8 A to the 24 V 2-pin DC power connector.
- ▶ For interfaces having a power pin such as external power or fan, ensure that the connectors and wires are suitably rated. All connections from/to the product shall be with SELV circuits only.
- ▶ Wires have suitable rating to withstand the maximum available power.
- ▶ The enclosure of the peripheral device fulfils the fire protecting requirements of IEC60950-1.

6.2. Power Connector

The BL Pi-Tron CM3+ is connected by the input power connector to a DC power source via a DC power supply wiring consisting of the power mating connector and the assembled wires. For information on how to wire the connector, see next Chapter.

Figure 7: Phoenix Power Mating Connector

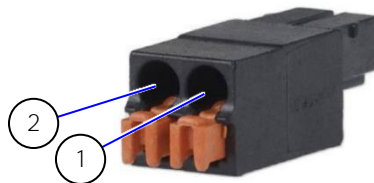

- 1 Location for inserting the 24 V wire
- 2 Location for inserting the 0 V wire

6.2.1. Wiring the DC Mating Power Connector

To wire the power mating connector, follow the steps below:

1. Cut two (0.5...1.5 mm²) AWG 20...16 isolated wires to the required length and strip each end 5...7 mm.
2. Twist the striped wire-ends and provide them with ferrules.
3. Press the contact levers of the power mating connector down - far enough so that you can insert the end of the prepared wires.
4. Insert the wires into the corresponding clamp of the Phoenix power mating connector. Make sure that you have the right polarity of the connection. For the pin assignment of the input power connector, refer to Chapter 3.2.1: Input Power Connector.



The wires used for power connections must be clearly marked (+/-) to ensure proper connection to the input power connector and to the main power source. In addition, the cables must have **some form of support to minimize the strain on the unit's connectors.**



ESD Sensitive Device!

Electrostatic discharge (ESD) can damage equipment and impair electrical circuitry.

- o Wear ESD-protective clothing and shoes.
 - o Wear an ESD-preventive wrist strap attached to a good earth ground.
 - o **Check the resistance value of the wrist strap periodically (OK: 1 MΩ to 10 MΩ).**
 - o Transport and store the board in its antistatic bag.
 - o Handle the board at an approved ESD workstation.
 - o Handle the board only by the edges.
-

7/ Starting Up

Before using the system, become familiar with the system components and follow the startup instructions below.

7.1. Connecting to Power Supply

The BL Pi-Tron CM3+ connects to a DC main power supply via a Phoenix Contact input power connector and corresponding power cable.



When starting the BL Pi-Tron CM3+, the functional earth connection must always be made first and disconnected last. Kontron Electronics recommended that the last connections attached to the system should be the power cable. Following a proper cabling procedure will prevent a false power-on condition, which could result in an operational failure.

CAUTION

The BL Pi-Tron CM3+ must be connected to a DC mains power supply complying with the SELV (Safety Extra Low Voltage) requirements of EN 60950-1 standard. It must be observed that wiring and short-circuit/overcurrent protection is performed according to the applicable standards, regulations and respect to the electrical specification of the BL Pi-Tron CM3+. The disconnecting device (fuse/circuit breaker) rating must be in accordance with the BL Pi-Tron CM3+'s wire cross-section.

To start the BL Pi-Tron CM3+, follow the steps below:

1. Ensure that the DC power source is switched off via a disconnecting device (circuit breaker), in order to ensure that no power is flowing from the external DC power source during the connection procedure.
2. Connect the power connector with wiring (refer to Chapter 6.1: Requirements IEC60950-1) to the Input power connector located at the front, see Figure 5 (pos. 1).
3. Pay attention to the polarity of the connections. For more information on the input power connector's polarity, see Chapter 3.2.1: Input Power Connector.
4. Connect the DC power cable's other end to the DC main power supply.
5. Switch on the disconnecting device (circuit breaker) in order to apply voltage to the BL Pi-Tron CM3+.

NOTICE

Do not disconnect the power from BL Pi-Tron CM3+ while powered up!
Performing a forced shutdown can lead to loss of data or other undesirable effects!

7.2. Operating System (OS) and Drivers

The standard BL Pi-Tron CM3+ is supplied *without* pre-installed OS. Guides to setup an OS and further information about the various interfaces of the BL Pi-Tron CM3+ are available from Kontron Electronics' online documentation at:

<https://docs.kontron-electronics.de/sw/ked/docs/docs/raspberry-pi-os/pi-tron-cm3/>

8/ Standards, Certifications and Directives

The BL Pi-Tron CM3+ is currently in test and aims to comply with the requirements of the following standards.



If the user modifies the product, prerequisites for specific approvals such as CE conformity declaration (safety requirements) may no longer apply.

Table 10: Standards, Certifications and Directives Compliance

CE-Mark Compliant with EU Directives	Electromagnetic Compatibility	Directive 2014/30/EU
	Low Voltage	Directive 2014/35/EU
	RoHS II	Directive 2011/65/EU
EMC 2014/30/EU Immunity/ Emission	EN 61000-6-2:2019-11 EN 61000-6-3:2011-09	Electromagnetic compatibility (EMC), part 6-2: Generic standards- Immunity for industrial environment Electromagnetic compatibility (EMC), part 6-3: Generic standards- Emission for industrial environment
WEEE 2002/96/ EC	Waste Electrical and Electronic Equipment Directive (WEEE Directive)	Compliant with the Waste Electrical and Electronic Equipment (WEEE) directive to reduce waste of electrical and electronic equipment, encourage recycling and environmental disposal and increase the environmental awareness of producers.

9/ Shipment and Unpacking

9.1. Packaging

All parts are delivered together in a product specific cardboard package designed to provide adequate protection and absorb shock. Kontron Electronics recommends keeping the packaging to store or transport the product.

9.2. Unpacking

Proceed as follows to unpack the unit:

1. Remove packaging.
2. Do not discard the original packaging. Keep packaging for future relocation or storage.
3. Check the delivery for completeness by comparing it with the original order.
4. Keep the associated paperwork. It contains important information for handling the unit.
5. Check the contents for visible shipping damage.
6. If you notice any shipping damage or inconsistencies between the contents and the original order, contact Kontron Electronics for help and information.

9.3. Type Label and Product Identification

The type label is position on contains the following information.

Figure 8: BL Pi-Tron CM3+ Type Label (Example)

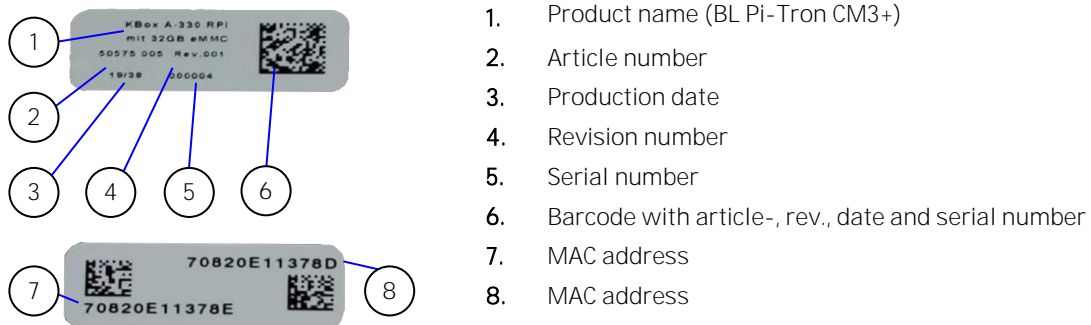

10/Technical Support

10.1. First Steps – Startup-Information Baseboard

For the first startup of your board, you will find more information about the Software / BSP (demo) and additional hardware information at the online documentation.

Please follow the link <https://docs.kontron-electronics.de/sw/ked/raspberry-pi/pi-tron/cm3-docs/quickstart/>

The online documentation is primarily intended for our Eval-Kit / Evalboard but will help you also to put your BL Pi-Tron CM3+ into operation. Additionally, you will find information how to get access to the Yocto based GitLab software repository and how to make your own software images.

10.2. Extended Support

For detailed technical support please contact:

▶ E-mail: support@kontron-electronics.de

Make sure you have the following product identification information in your e-mail:

- ▶ Product name
- ▶ Product model number
- ▶ Serial number (SN) of the unit

Please explain the nature of your problem in your e-mail.



The serial number can be found on the type label on the system.

10.3. Disclaimer & License Information

Note that the Raspberry Pi OS, obtained from <https://www.raspberrypi.com/software/>, contains licensed as free respectively open-source software under the GNU General Public License, version 2 and/or 3, respectively the GNU Lesser General Public License, versions 2.1 and/or 3.0 and others. Check the respective copyright notices of the package(s) in question.

You can also contact us at:

Kontron Electronics GmbH

Max-Planck-Str. 6
72636 Frickenhausen
Germany

www.kontron-electronics.com

E-Mail: support@kontron-electronics.de

11/Storage, Transportation and Maintenance

11.1. Storage

If the product is not in use for an extended period time, disconnect the power plug from the AC outlet. If it is necessary to store the product then re-pack the product as originally delivered to avoid damage. The storage facility must meet the products environmental requirements as stated within this user guide. Kontron Electronics recommends keeping the original packaging material for future storage or warranty shipments.

11.2. Transportation

To ship the product, use the original packaging, designed to withstand impact and adequately protect the product. When packing or unpacking products always take shock and ESD protection into consideration and use an EOS/ESD safe working area.

11.3. Maintenance

Maintenance or repair on the open product may only be carried out by qualified personnel authorized by Kontron Electronics.

Cleaning

- ▶ For light soiling, clean the product with a dry cloth.
- ▶ Carefully remove dust from the surface of the chassis and cooling fins using a clean, soft brush.
- ▶ Stubborn dirt should be removed using a mild detergent and a soft cloth.

NOTICE

Do not use steel wool, metallic threads or solvents like abrasives, alcohol, acetone or benzene for cleaning the BL Pi-Tron CM3+.

11.3.1. Replacing the Lithium Battery

The lithium battery must only be replaced with the same type of battery or with a type of battery recommended by Kontron Electronics. If the on-board Lithium battery needs to be replaced, follow the steps below:

1. Remove the lithium battery from the holder by pulling it outwards.
2. Place a new lithium battery in the battery holder.
3. Pay attention to the polarity of the battery.

CAUTION

Danger of explosion when replacing with wrong type of battery. Replace only with the same or equivalent type recommended by the manufacturer. The lithium battery type must be UL recognized.



Do not dispose of lithium batteries in general trash collection. Dispose of the battery according to the local regulations dealing with the disposal of these special materials, (e.g. to the collecting points for dispose of batteries).

12/Warranty

Kontron Electronics defines product warranty in accordance with regional warranty definitions. Claims are at Kontron Electronics' discretion and limited to the defect being of a material nature. To find out more about the warranty conditions and the defined warranty period for your region, following the steps below:

1. Visit Kontron Electronics' Term and Conditions webpage.

<http://www.kontron-electronics.de/downloads>

2. Click on the relevant document.

12.1. Limitation/Exemption from Warranty Obligation

In general, Kontron Electronics shall not be required to honor the warranty, even during the warranty period, and shall be exempted from the statutory accident liability obligations in the event of damage caused to the product due to failure to observe the following:

- ▶ General safety instructions for IT equipment within this user guide.
- ▶ Warning labels on the product and warning symbols within this user guide.
- ▶ Information and hints within this user guide.

Additionally, alterations or modifications to the product that are not explicitly approved by Kontron Electronics, described in this user guide, or received from Kontron Electronics Support as a special handling instruction will void your warranty.

Within the warranty period, the product should only be opened by Kontron Electronics. Removing the protection label and opening the product within the warranty period exempts the product from the statutory warranty obligation.

Due to their limited service life, parts which by their nature are subject to a particularly high degree of wear (wearing parts) are excluded from the warranty beyond that provided by law.

13/ Disposal

Final disposal of this product after the product's service life must be accomplished in accordance with the applicable country, state, or local laws or regulations.



Kontron Electronics manufactures products to satisfy environmental protection requirements where possible. Many of the components used are capable of being recycled.

Kontron Electronics follows the Waste Electrical and Electronic Equipment (WEEE) Directive that aims to reduce waste arising from Electrical and Electronic waste and encourages customers to return Kontron Electronics products for proper disposal. For more information regarding WEEE compliance, see the Disposal and Recycling section at the start of this user guide.

Appendix

List of Acronyms

Table 11: List of Acronyms

AC	Alternating Current
AL	Automation Line (Board with enclosure)
BL	Board Line (Board without enclosure)
BSP	Board Support Package (Software)
CAN	Controller Area Network (BUS)
CPI	Advanced Configuration Control Interface
CPU	Central Processing Unit
CSI	Camera Serial Interface
DC	Direct Current
DIN	Deutsches Institut für Normung, German Institute for Standardization (Standards)
DIO	Powerful Digital Input/Output
DK	Development Kit
DL	Display Line (Board with Display)
Dout	Digital Output
DP	Display Port
DSI	Display Serial Interface
ECC	Error Checking and Correction
EEE	Electrical and Electronic Equipment
EHCI	Enhanced Host Controller Interface
EMC	Electromagnetic Compatibility
eMMC	Embedded MultiMediaCard
EN	European Norm (Standards)
ESD	Electrostatic Discharge
ETH	Ethernet (LAN)
GbE	Gigabit Ethernet
GPIO	General-Purpose Input/Output
GPU	Graphics Processing Unit
HD/HDD	Hard Disk /Drive
HDMI	High Definition Multimedia Interface
HPM	PICMG Hardware Platform Management specification family
H/W	Hardware
IEC	International Electrotechnical Commission (Standards)
IOL	IPMI-Over-LAN
IOT	Internet of Things

KVM	Keyboard Video Mouse
LAN	Local Area Network
LED	Light Emitting Device / Diode
LPDDR	Low-Power Double Data Rate (RAM)
LVD	Low Voltage Device
M.2	Next smaller generation of mSATA
MEI	Management Engine Interface
mPCIe	Mini PCI-Express
mSATA	Mini SATA
OS	Operating System
PCIe	PCI-Express
RAM	Read Access Memory
REV	Revision
RoHS	Restriction of the use of certain hazardous substances
ROM	Read-only memory
RPI	Raspberry Pi
RTC	Real Time Clock
SATA	Serial-ATA
SEL	System Event Log
SELV	Safety Extra Low Voltage
SIO	Super Input/output
SMBus	System Management Bus
SMWI	System Monitor Web Interface
SN	Serial Number
SOL	Serial Over LAN
SSD	Solid State Drive
TPM	Trusted Platform Module
UEFI	Unified Extensible Firmware Interface
uHDMI	Micro-HDMI
UL	Underwriters Laboratories (Standards)
USB	Universal Serial Bus
USB OTG	USB On-The-Go (Host)
VGA	Video Graphics Array
VLP	Very Low Profile
WEEE	Waste Electrical and Electronic Equipment
WLAN	Wireless LAN
XHCI	eXtensible Host Controller Interface



About Kontron Electronics

Kontron Electronics is your complete supplier of electronics and automation solutions. We offer

- ▶ own control products for the automation of machines and devices,
- ▶ development and production for individual, complex electronic modules
- ▶ production services for your existing electronic assemblies
- ▶ assembly services for complete systems

With our existing control, visualisation and automation systems, we can put together turnkey complete solutions for your machines and equipment in the shortest possible time. For your individual requirements we have a large group of engineers and technicians available, who develop your tailor-made solution with a lot of experience and imagination. Kontron Electronics is a full-service provider for the development and production of complex electronic modules, components and systems for industrial and medical applications.



Kontron Electronics GmbH

Max-Planck-Str. 6
72636 Frickenhausen
Germany
Tel.: + 49 7022 4057-0
Fax: + 49 7022 4057-22
info@kontron-electronics.de